



WELCOME TO
THE ACADEMY



UFA x Arsenal F.C.
London, England
March 28 – April 6, 2025





inspiresport™



sports
breaks
.com

SPORTSWORLD®

Destination Sport Group sets the global standard in sports travel,
offering our partners a tailored approach and best-in-class solution
via seven market leading divisions

OUR BACKGROUND

- Leaders of International Soccer Travel & Programming
- Atlanta Headquarters, Manchester Office
- Soccer Company Run By Soccer People
- 20+ Years Of Experience
- 500+ International Trips Per Year
- 20,000+ Players Moved

WHAT MAKES US UNIQUE



- Exclusive access to professional clubs, tournaments and federations around the world.
- Adidas partnership.
- Premier access to soccer worldwide.
- Experts in the industry.
- Staff around the world.
- Customer Service – US based and UK based teams.



WHAT IS TEAM TRAVEL?

TRAIN LIKE A PROFESSIONAL

Train with certified coaches at state-of-the-art facilities. Experience the life of a European youth Academy player!

TOUR PROFESSIONAL STADIUMS

Get behind the scenes glimpse of your favorite stadiums! See the trophies won, see the field from the team bench, and visit the locker rooms.

CULTURAL SIGHTSEEING

Experience a European capital, including its local culture, language, and food! Visit important historical sites and learn about local life.

ATTEND PROFESSIONAL MATCHES

See the greats of teams such as Arsenal F.C. in person and watch the stars perform live!

PLAY COMPETITIVE FRIENDLY MATCHES

Challenge your game by playing against top quality local opponents. Learn about the local style of play first-hand!

Multi-Disciplinary Approach

How We View Sports Travel

Technical & Tactical

- Train with the best teams and develop with the best coaches.
- Experience and be part of the best youth development environments and facilities.
- Understand and appreciate what an Academy player in Europe faces, and how his success is created and supported.
- Be exposed to coaching styles and a way of learning that supports the individual development of all players within a team dynamic.

Games Programme

- Take part in a games programme that provides challenge and effective opposition.
- Be placed outside of your comfort zone and put in a position where you must learn how to adapt in games where cultural styles will create challenge and resistance.
- Grow with your teammates to problem solve and succeed together.
- Be able to use what has been learned in training when in the game environment.

The Player

Social

- Be placed in a situation where you are traveling with your teammates to a foreign country and allow it to help you grow closer together.
- Experience the thrill of training in the best professional environments in the world and living a shared experience with your friends and teammates.
- Learn as a team to deal with challenge and the differences of being abroad as you have to adapt and overcome together.
- Be able to meet and interact with your peers in Europe and share your experiences of soccer and life.

Cultural

- Experience what about Europe and its football heritage provides such an enriching learning environment and opportunity to bond as a team.
- Get to learn about the culture and history of the places you stay and create memories that are irreplaceable or impossible to recreate anywhere else.
- Be able to share these experiences with your family.
- Try new food and experience the closeness of European cities.
- Attend live matches and *feel* the noise and atmosphere change your perspective overnight.



FOOTBALL DEVELOPMENT

Arsenal Football Development welcome United Futbol

SHARE

Arsenal Media

01 Jul 2024



Your trip includes:

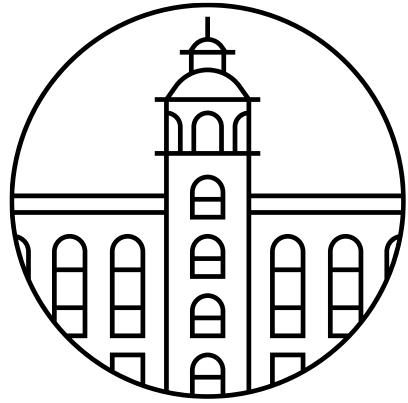

8 nights accommodation in a 3* or 4* hotel



2 meals per day: Breakfast each day and Lunch or Dinner

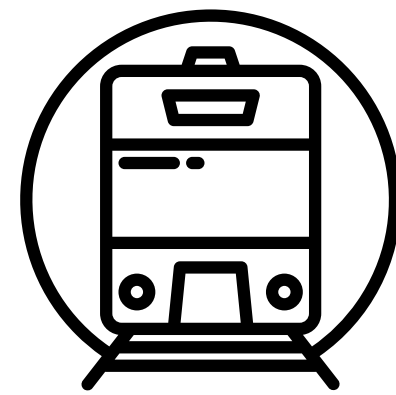

All ground transportation throughout program



Team Coordinators to be with team 24/7

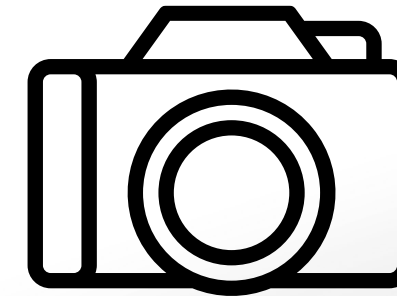

Sightseeing and Cultural Activities, including visits to attractions



Laundry for Players (Uniforms - 3 loads)



4 training sessions with Arsenal F.C. coaches



3 pre-arranged friendly games against competitive local opponents

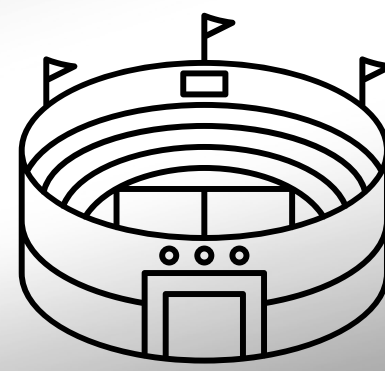

Behind the scenes stadium tours from official club staff



All training session fields and equipment

Landed Package – Pricing & Payment Schedule

PLAYER	SUPPORTER
\$2,825	\$2,525
Early Bird Discount = \$2,675	Early Bird Discount = \$2,375

*Early bird discount ends on **September 6th!!**

Registration

- Deposit \$295 per person

Progress Payment 1

- **OCTOBER 4**
- \$550 per person

Progress Payment 2

- **NOVEMBER 15**
- \$550 per person

Final Payment

- **JANUARY 24**
- \$ remaining balance



GROUP FLIGHT INFORMATION

Flight Cost: \$1,235

Because it is a Group Flight, a minimum of 10 people must register for the Group Flight (airline policy).

Group flight seats are FIRST COME-FIRST SERVE.: 35 SEATS AVAILABLE PRESENTLY

Registration

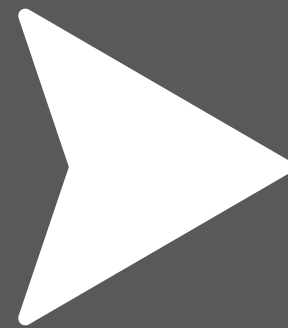

Deposit
\$200 per person

TBC

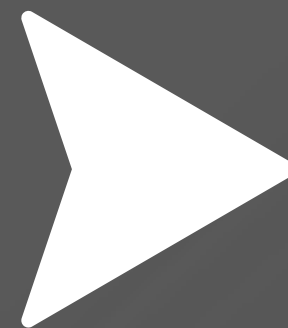

\$ Remaining
balance

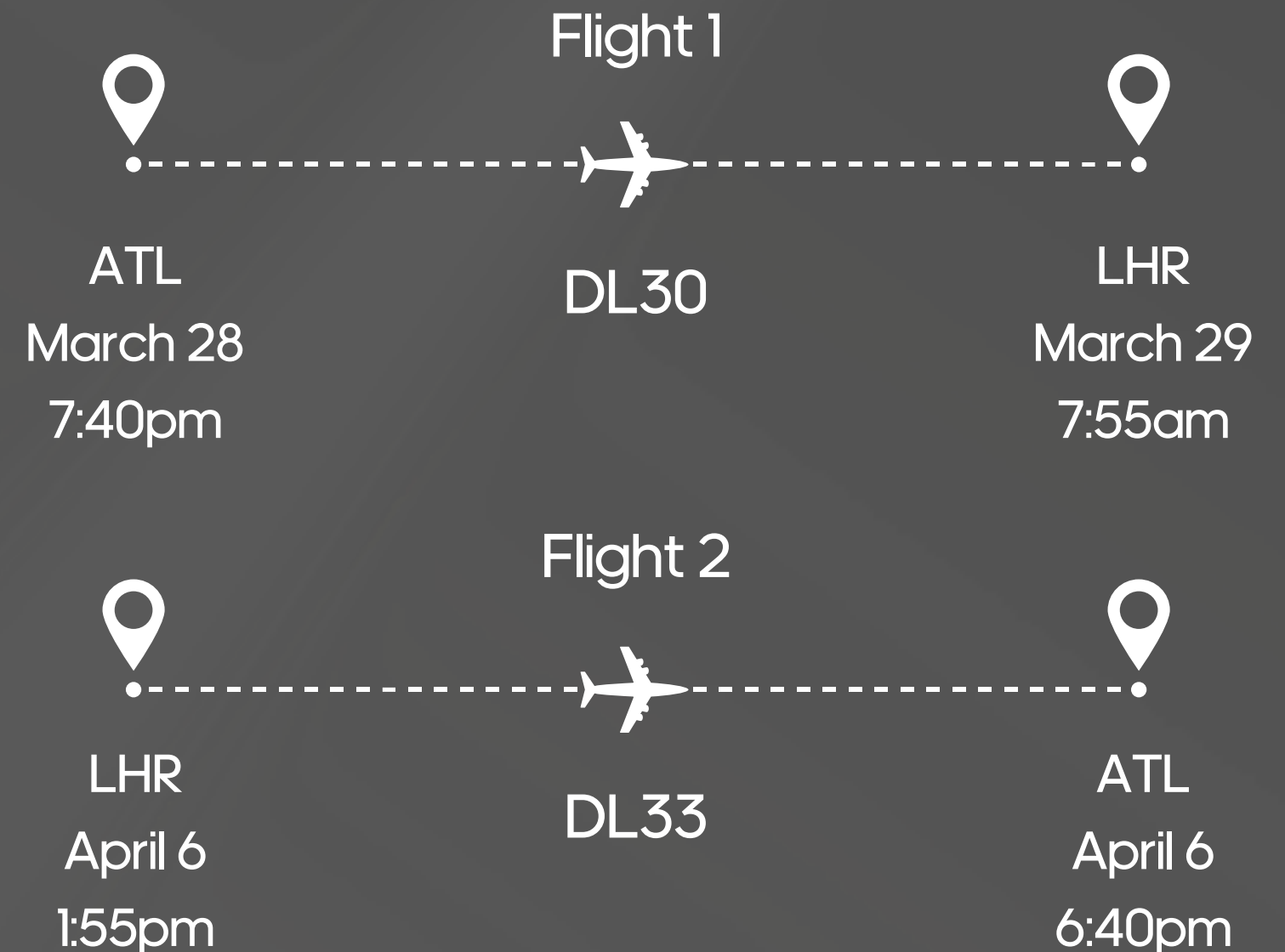

*You can also pay for the entire flight in full, instead of paying instalments.

LOGISTICS

Team Coordinator With Group 24/7

- Darran Walter – Senior Team Coordinator
- Highly trained, professional individuals
- Local and have strong knowledge of the area
- Ex-Premier League Staff

- Deliver the Itinerary
- Create the Memories
- What do players and parents experience in England?

Private Coach Transportation

- To & from all activities and excursions



ACCOMMODATION

Double Occupancy

- Means two guests per room.
- UFA club directors to facilitate room assignments.
- **Players 12 and under at the time of travel will need to room with supporter.**
- **Select Double Occupancy for ALL SUPPORTERS if there is more than 1 Supporter in your party.**
- Otherwise, supporters will room with supporters. Must identify roommate...we will not randomly assign.

Single Occupancy

- Means you have your own room.
- If you are traveling alone with your child and the Club has asked for players to room together and you **DO NOT WANT** to share a room with another supporter, then please select **SINGLE ROOM** when you checkout. This includes a Single Room Supplement.
- Players will **ALWAYS** be **DOUBLE** room occupancy because they cannot room alone.

TICKETS TO PROFESSIONAL GAMES

Tickets to Professional Matches (Premier League, La Liga, EFL Championship etc) are **NOT INCLUDED** in the price.

- These are extras that we will provide options for once we know TV schedules and allocations from our professional club partners. Tickets to games can never be guaranteed.

SUPPORTER PACKAGE



"What if we are a supporter and want to book our own transport/hotel/meals but just have our son/daughter stay with you?"

- This is absolutely fine, and you are welcome to do that! However, please note that everything becomes your responsibility at that point and if we do get tickets for any Professional Games, you won't be included on the allocation we request. It also means access to training sessions could be denied as that is only open to registered participants.



Travel with peace of mind and our COVID-ready benefits

What is eligible for coverage?



Trip Cancellation

A diagnosis of COVID, or a physician ordered quarantine, for yourself or a traveling companion that causes you to cancel your trip.



Trip Interruption

You, or a traveling companion, are diagnosed with COVID or placed under physician ordered quarantine during your trip.



Trip Delay

Your return home is delayed, by 5 hours or more, due to a positive COVID diagnosis or a physician ordered quarantine; and you have additional expenses due to the longer stay.



Medical

You, or a traveling companion, have a new or unforeseen illness or injury, including COVID, that requires you to be treated by a physician.



Travel Assistance

Travel assistance is available 24/7 to assist with COVID questions before and during your trip.



Traveling Companion

You have an extended hospital stay, over 7 days, and your traveling companion has additional costs for meals and hotels to remain near you.

INSURANCE

- Optional to purchase post-Covid.
- Handled directly through Travelex.
- Must purchase within 15 days of trip registration to cover pre-existing conditions.
- If you want to purchase Insurance at all, it must be purchased no later than 21 days before your trip.
- Does not have to be Travelex, but strongly recommend you get some form of protection.



DEPOSITS & TRAVEL INSURANCE

Deposits are [non-refundable per person.](#)

- Our cancellation policy and refund eligibility for the landed package are based on the below:

Days to Departure	Refund Amount
181 Days + from Departure	Full Refund minus deposit per person.
180 to 121 Days to Departure	Full Refund minus \$595 per person.
120 to 91 Days to Departure	50% Refund of the Landed Package.
90 to 61 Days to Departure	25% Refund of the Landed Package.
60 or less Days to Departure	No Refund.

Pre-Trip Timeline

01 9-12 Months Out

- Trip Registration Open
- Group Flight Open & Flight Utilization Date Posted
- Deposit Payments Due (by Deadline)
- Initial Communication and Information Newsletter
- Draft Itinerary Available
- Trip Registration Deadline – Registration CLOSES
- Recommended – Purchase Travel Insurance

03 3 Months Out

- Passport Information Required
- Flight Information Required (if not on Group Flight)
- Hotels Made Available
- Room Blocks Confirmed with Coaches

05 1 Month Out

- **Provisional Itinerary Provided**
- Airport Transfer Details Provided

07 2 Weeks Out

- eTickets for Group Flight Provided
- Tickets for Professional Games posted to Accounts

09 Day of Travel

- WhatsApp Groups Created for Communications

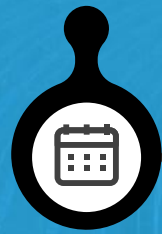

02 5-6 Months Out

- Group Flight Passenger Confirmation

04 6 Weeks Out

- Pre-Trip Parent Call – FAQs + Itinerary Outline
- Explanation of Possible Live Game Options (where applicable)

06 3 Weeks Out

- Promo Product Delivered (where applicable)

08 1 Week Out

- Team Coordinators Details Provided
- Final Itinerary Provided
- Final Balances Due for Match Tickets

REGISTRATION / NEXT STEPS

UFA Directors and/or NGI will be sending out the link with website/registration details within 24hrs.

EARLY BIRD DISCOUNT ENDS:

September 6th, 2024

FINAL DEADLINE FOR ALL PLAYERS, SUPPORTERS, & STAFF TO REGISTER:

October 31st, 2024

**We will not be accepting registrations after October 31.*

THANK YOU

We appreciate you taking the time to listen to our presentation, we can't wait to take you and your team on the trip of a lifetime. If you have any questions, please don't hesitate to contact us.

Organization Contacts:

- Questions about trip contact Katie Kaufmann:
katie.kaufmann@inspiresportglobal.com
- Questions about registration contact Amy Rossi:
amy.rossi@inspiresportglobal.com

